



This Datasheet for the

IC670CHS003

I/O Base, Connector Style

<http://www.qualitrol.com/shop/p-14503-ic670chs003.aspx>

Provides the wiring diagrams and installation guidelines for this GE Field Control module.

For further information, please contact Qualitrol Technical Support at

1-800-784-9385

support@qualitrol.com

I/O Terminal Block with Connectors

GFK-1188E
August 1997

IC670CHS003
IC670CHS103

Description

I/O Terminal Blocks are generic wiring bases that provide module mounting, backplane communications, and terminals for user connections. Two modules can be installed on one terminal block. Modules screw onto the terminal block for vibration resistance. Modules can be removed without disturbing field wiring.

The I/O Terminal Block with Connectors (catalog number IC670CHS003) has two 20-pin male connectors for I/O wiring. The mating connector is Amp part number 178289-8. The connectors are keyed to prevent incorrect insertion. Any tin-plated contact in the AMP D-3000 series can be used with the connector (Amp part number 1-175217-5 for high contact force receptacle for 20-24 gauge (0.20-0.56mm²) wires), 1-175218-5 for high contact force receptacle for 16-20 gauge (0.56-1.42mm²). A kit containing two mating connector housings and contacts is available as GE Fanuc part number IC670ACC003. A crimping tool is not provided.

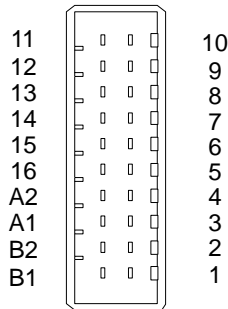

The safety ground wire should be AWG #14 (avg 2.1mm² cross section), not more than 4 inches (10.16 cm) long.

I/O Terminal Block IC670CHS103 permits hot insertion/removal of modules without affecting the Bus Interface Unit or other modules in the I/O Station. Hot insertion/removal can only be performed in non-hazardous locations.

Compatibility

I/O Terminal Block IC670CHS103 has a projecting alignment slot at each module position. It must be used with modules whose catalog number suffix is J or above. These modules have a projecting tab that fits into the alignment slot.

Bus Interface Unit version 2.1 or later is required for hot insertion/removal of modules in the I/O Station.

Mixing IC670CHS10x terminal blocks with IC670CHS00x terminal blocks in the same I/O station is not recommended.

Caution

This Terminal Block must be used with a grounded conductive DIN rail.

Installing a Terminal Block on a DIN Rail

1. Tilt the I/O Terminal Block and position it over the rail, catching the rail behind the tabs in the terminal block.

2. Pivot the terminal block downward until the spring-loaded latches click into place.

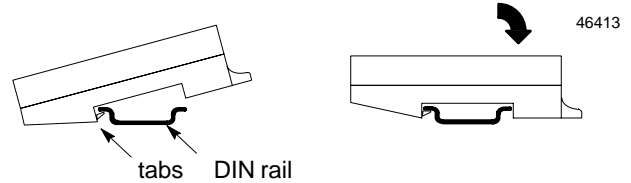

3. Tighten the DIN rail clamp screw. Maximum recommended torque is 8 in/lb to 10 in/lb.

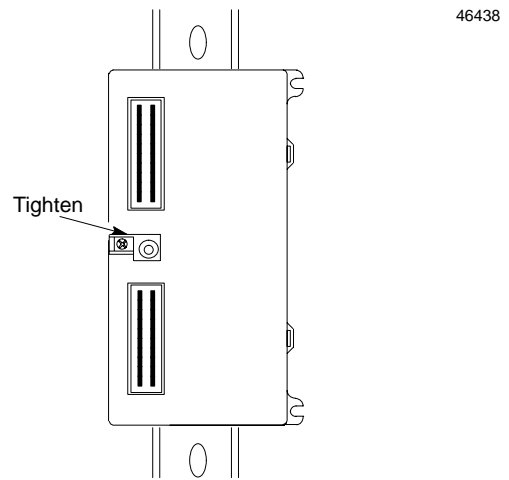

Removing the I/O Terminal Block from a DIN Rail

Follow the steps below to remove the I/O Terminal Block. (If Auxiliary Terminal Blocks have been used, they must be removed first.)

1. Loosen the DIN rail clamp screw.
2. Insert a small flat-blade screwdriver into the upper latch and pry it outward.
3. Pull up gently on the top of the terminal block to disengage the upper latch from the rail. Insert the screwdriver into the lower latch and pry it outward to free the terminal block.

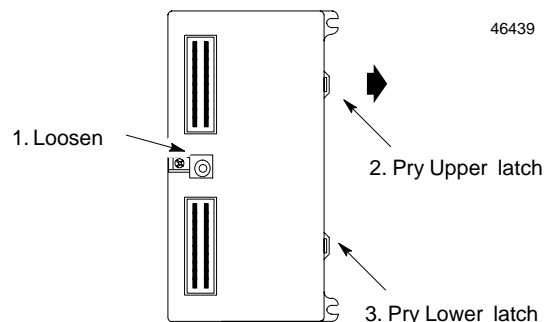

GFK-1188E

Connecting Bases

Before installing modules on their terminal blocks, install the connecting cable(s). The cable illustrated below is supplied with the I/O Terminal Block. A set of these cables is available as renewal part number IC670CBL001. Optional 21 inch (0.53 meter) cable (IC670CBL002) is also available (only one longer cable can be used per I/O station).

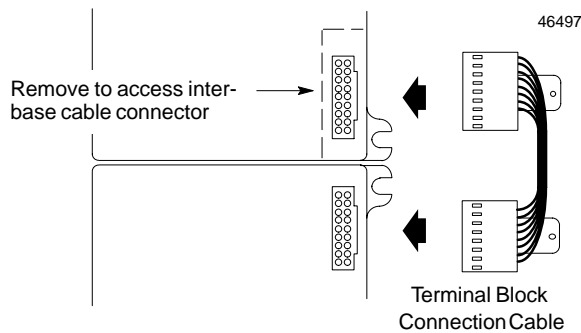

The connectors are keyed to assure proper installation. **After installing the cable, be sure it is firmly seated on both connectors.**

Wiring for I/O Modules

In general, I/O wires and communications bus cable can be placed randomly in a wiring trough for lengths of up to 50 feet. If wiring is cord-tied (harnessed), do not include the bus cable in the harness, since binding wires tightly together increases the coupling and mechanical stress that can damage the relatively soft insulation of some serial cable types. For more information about noise immunity, please refer to the *I/O Modules User's Manual*.

Power Wiring

I/O modules require field-side power for I/O devices. Power supply connections can easily be "daisy-chained" between modules with similar power requirements. Alternatively, separate supplies can be used on any combination of modules to provide isolation as needed. The location of the power connection on an I/O module depends on the module type. The table below shows I/O module terminal assignments.

Suppression at the Output Load: For information about suppression, please refer to the *I/O Modules User's Manual*.

Using a Crimping Tool

The pins provided with this Terminal Block must be installed on individual wires using a crimping tool. The AMP™ Pro-Crimper™ II, Hand Tool Assembly 90546-1 is recommended. The tool must be properly adjusted, as detailed in the instructions that come with the tool.

1. Strip the wire 3.96 to 4.75mm (0.156 to 0.187in), taking care not to nick or cut wire strands.
2. Hold the tool with the back (wire side) facing you. Squeeze tool handles together and allow them to open fully.
3. Holding the contact by the mating end, insert the contact—insulation barrel first—through the front of the tool into the appropriate crimp section. Position the contact with the mating end on the locator side of the tool, so that the open "U" of the wire and insulation barrels face the top of the tool. Place the contact up into the nest so that the movable locator drops into the slot in the contact. Butt the front end of the wire barrel against the movable locator.

NOTE: Be sure both sides of the insulation barrel are started evenly into the crimping section. **DO NOT** attempt to crimp an improperly-positioned contact.

4. Hold the contact in position and squeeze the tool handles together until ratchet engages enough to hold the contact in position. **DO NOT** deform insulation barrel or wire barrel.
5. Insert stripped wire into contact until it is butted against wire stop as shown.
6. Holding wire in place, squeeze tool handles together until ratchet releases.
7. Check the contact's crimp height as described in the tool instruction sheet. Adjust the crimp height if necessary before continuing.

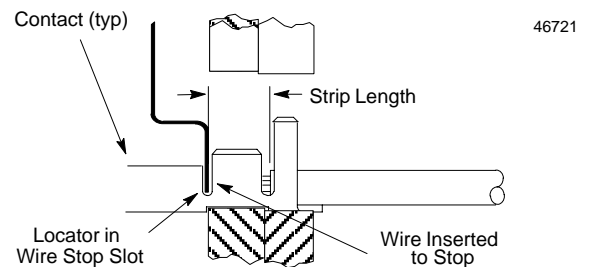

I/O Module Keying (optional)

The I/O Terminal Block is provided with a set of small keys that fit into lettered slots on the terminal block. Use of keying is recommended to ensure installation of the correct type of module in each location.

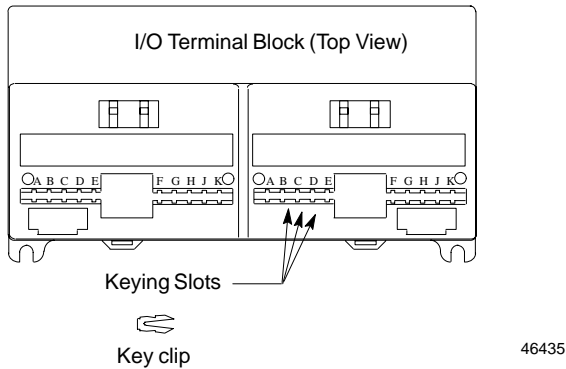

Refer to the following table for keying locations for various types of I/O modules. The check marks in the table correspond to the keying slots in the I/O Terminal Block.

Module ID: IC670...	Keying Locations										
	A	B	C	D	E	F	G	H	J	K	
MDL240		✓			✓	✓	✓	✓			
MDL241			✓		✓	✓	✓	✓			
MDL330,MDL331		✓				✓	✓	✓			
MDD441,MDL640, MDL644	✓		✓				✓	✓			
MDL641		✓		✓			✓	✓			
MDL642	✓				✓		✓	✓			
MDL643	✓	✓					✓	✓			
MDL730,MDL740, ALG320,ALG330	✓		✓						✓	✓	
MDL233		✓			✓	✓				✓	
MDL742	✓	✓							✓	✓	
MDL930			✓	✓	✓	✓	✓	✓			
ALG230,ALG240	✓			✓			✓	✓			
ALG630,ALG620	✓			✓					✓	✓	
ALG310	✓			✓						✓	

Module Installation

Caution

Electrostatic discharge can damage an I/O Module when it is not installed on an I/O Terminal Block. Always observe good ESD protection practices when handling an un-installed module.

If the protective label is still in place on the I/O Terminal Block, remove it before attempting to install an I/O Module.

Installing an I/O Module on the Base

1. Before installing a module, remove the cable slot knockout(s) where the module would cover the connecting cable. The knockouts can be removed with pliers or by pressing *out* from inside the housing.

2. To install an I/O module, position the module so that the cable slot in the module housing is over the connecting cable. Press the module down firmly.

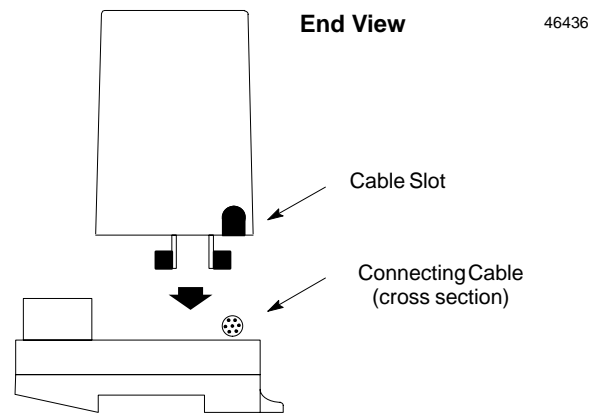

3. If you feel resistance, remove the module and check the keying (if keying has been used). Also be sure the connecting cable is in the cable slot.
4. After placing an I/O module onto the base, tighten its bolts to secure it. Maximum recommended torque is 9 in.lbs.

Removing Power

For I/O Terminal Blocks without the special alignment slot (IC670CHS001, 002, and 003), inserting or removing an I/O module during station operation may cause incorrect data to be generated for the entire I/O station.

I/O Terminal Blocks with the projecting alignment slot (IC670CHS101, 102, 103) are designed for module hot-insertion. With these terminal blocks, modules can be inserted/removed without removing power to the I/O station or affecting other devices in the I/O station. External power to the module itself must be removed for hot insertion/removal. Hot insertion/removal can only be performed in non-hazardous locations.

Note: Inserting or removing an I/O module during station operation may cause incorrect data to be generated.

Warning

This equipment is suitable for use in Class I, Division 2, Groups A, B, C, and D or in non-hazardous locations only.

WARNING—Explosion Hazard—Substitution of components may impair suitability for Class I, Division 2.

WARNING—Explosion Hazard—Do not disconnect equipment unless power has been switched OFF or the area is known to be non-hazardous.

When in hazardous locations, turn off power before replacing or wiring modules. Do not remove or insert external modules with power applied. Personal injury, system malfunction and/or damage to the equipment may occur.

In non-hazardous locations, for personal safety field power should be off while removing or inserting a high-voltage I/O module. Avoid contact with module wiring and with the exposed connectors on the I/O Terminal Block.