



This Datasheet for the

**[IC660BSM021](#)**

BUS Switching Module 24/48vDC

**<http://www.qualitrol.com/shop/p-14450-ic660bsm021.aspx>**

Provides the wiring diagrams and installation guidelines for this GE Series 90-30 module.

For further information, please contact Qualitrol Technical Support at

**1-800-784-9385**

**[support@qualitrol.com](mailto:support@qualitrol.com)**

GFK-0072D  
November 1991

## Bus Switching Module

- A Bus Switching Module connects Genius I/O blocks to dual communications cables
- Multiple BSMs can be used on the same dual serial bus.
- Simple, reliable operation
- BSM operation is controlled by a Genius I/O block
- BSM can be forced and unforced from the CPU or Hand-held Monitor
- LED indicates which bus is active
- Two models are available:
  - 24/48 VDC (IC660BSM021)
  - 115 VAC/125 VDC (IC660BSM120)

The Genius I/O system **Bus Switching Module (BSM)** is a simple, reliable device used to connect I/O devices to two serial busses at the same time. Two versions are available: the 115 VAC/125 VDC Bus Switching Module (IC660BSM120) and the 24/48 VDC Bus Switching Module (IC660BSM021).

One BSM can connect up to eight discrete and analog blocks to a dual bus. Using additional BSMs permits up to 30 I/O blocks to interface to the same dual bus.

This dual bus configuration can be used to provide a backup communications path to be used in case of bus failure.

Each bus of a dual bus pair is connected to a bus interface module (Bus Controller or PCIM). If each bus interface module resides in a different CPU, the system can also support CPU redundancy.

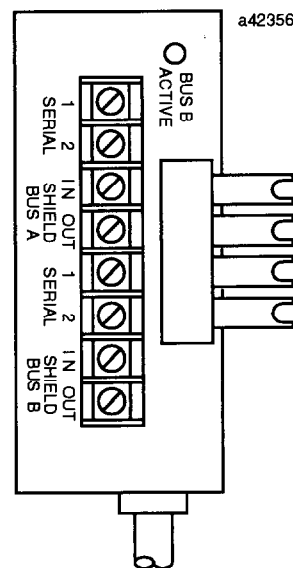

A phase B discrete block in the cluster controls the operation of the Bus Switching Module. The first circuit on this discrete block functions as an output dedicated to the BSM. This output causes the BSM to switch busses if communications are lost on the current bus.

If an operational bus cannot be found with one switch of the BSM, the BSM waits until communication is restored on the connected bus, or until power is cycled to the BSM controller block. This prevents unnecessary switching by the BSM when no communications are present. De-energized, the BSM connects the block(s) to bus A. The BSM is energized only when selection of bus B is required.

The LED on the Bus Switching Module lights when bus B is active.

The BSM can also be commanded to switch busses by the CPU or Hand-held Monitor.

GFK-0072D

### Multiple BSMs on a Bus

More than one BSM can be used on a dual bus.

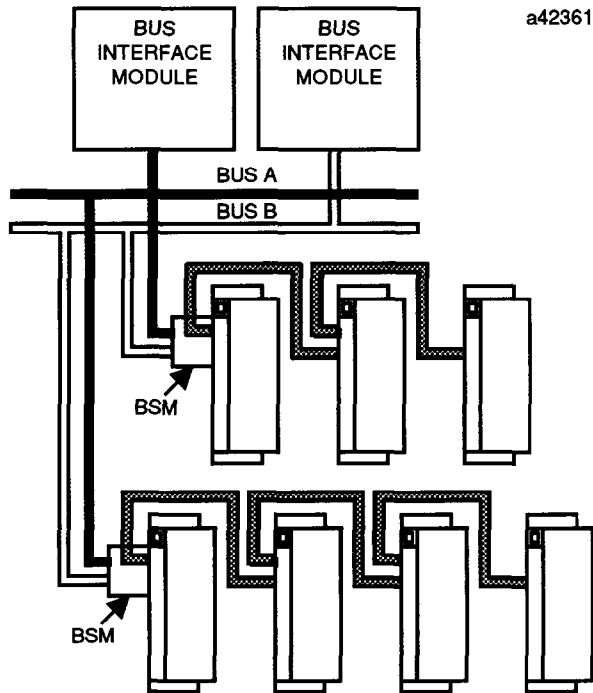

*This could be two 10' stubs with up to 8 blocks on each, or four 5' stubs, with fewer blocks on each. Additional BSMs can be located elsewhere on the bus.*

No 20% increment can have more than 20' of bus stubs.

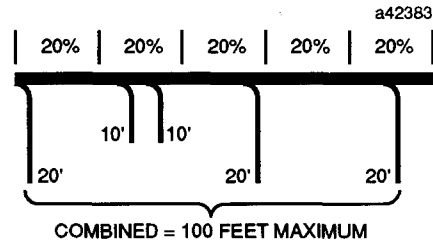

The locations of BSMs depend on the type of bus trunk cable and baud rate, as explained below.

### BSM Stub Distribution

The maximum length of all stubs on a bus should be 100 feet or less. Within each 20% section of the actual bus length, the total maximum stub length is 20 feet.

*For example, for a trunk cable 3000' long, 20% of the trunk cable length is 600'. Therefore, 20' of bus stub cable can be located within any 600' section of the bus.*

The 20' stub cable length can be divided into shorter stubs, provided that the total of the stubs in each incremental section of the bus is 20' or less.

*For the same example, the maximum length of all stubs over any 600' span of the serial bus is 20 feet.*

Cable # & Make	Maximum Trunk Cable Length feet/meters at baud rate			
	153.6s	153.6e	76.8	38.4*
(A)9823 (B)9182 (B)89182 (C)4596	2000ft 606m	3500ft 1061m	4500ft 1364m	7500ft 2283m
(B)9841	1000ft 303m	1500ft 455m	2500ft 758m	3500ft 1061m
(A)9109 (A)9818C (A)9818D (B)9207 (B)89207 (B)9815 (C)4798	1500ft 455m	2500ft 758m	3500ft 1061m	6000ft 1818m
(A)9110 (A)9818 (B)9855 (B)89696 (B)89855	1200ft 364m	1700ft 516m	3000ft 909m	4500ft 1364m
(A)9814 (A)9814C (B)9463	800ft 242m	1500ft 455m	2500ft 758m	3500ft 1061m
(A)5902C (B)9302	200ft 30m	500ft 152m	1200ft 333m	2500ft 758m

Notes: A = Alpha, B = Belden, C = Consolidated  
\* Limited to 16 taps at 38.4 Kbaud

### Installing the BSM

The Bus Switching Module mounts to the side of a phase B block. This block must provide an output circuit to control the switching operation of the BSM. The following types of blocks can be used as the BSM controller.

BSM Type	Block Type	
Both	Relay Output blocks	IC660BBR100/101
BSM120	8 Ckt 115VAC I/O	IC660BBD100/101
BSM120	8 Ckt 115VAC/125VDC Iso.	IC660BBS100/101
BSM021	16 Ckt 24/48VDC Source	IC660BBD020
BSM021	16 Ckt 24 VDC Source	IC660BBD022
BSM021	16 Ckt 24/48VDC Sink	IC660BBD021
BSM021	16 Ckt 24 VDC Sink	IC660BBD023
BSM021	32 Ckt 12/24VDC Source	IC660BBD024*
BSM021	32 Ckt 5/12/24VDC Sink	IC660BBD025*
BSM021	Current Source Analog	IC660BBA024/104
BSM021	Current Source Analog Out.	IC660BBA025/105
BSM021	Current Source Analog In.	IC660BBA026/106
BSM021	Thermocouple	IC660BBA023/103

\* BSM version IC660BSM021 has been notched to fit against the larger Terminal Assembly of a 32-circuit DC block. A 32-circuit DC block must operate at 24 VDC nominal to act as a BSM controller.

Install the BSM on the side of the BSM controller block as described below.

1. Remove the grounding screw located on the top left side of the block, behind the bus connection terminals. Use the grounding screw in the lower ground location to ground the block.
2. Loosen the Serial 1 and 2 and Shield In and Out terminal screws on the controller block.
3. Insert the BSM connectors under the terminals.
4. Using #10-32 x 1/2 pan-head screw and matching lock washer, bolt the BSM to the upper grounding hole.
5. Do not tighten the terminal screws until bus stub wiring is complete.

6. Connect the BSM like a load to circuit 1 on the block. See the block's data sheet for wiring information. As an example, connection for an 8-circuit AC block is shown below.

The "pigtail" wires used to connect the Bus Switching Module to its controller block are not polarized.

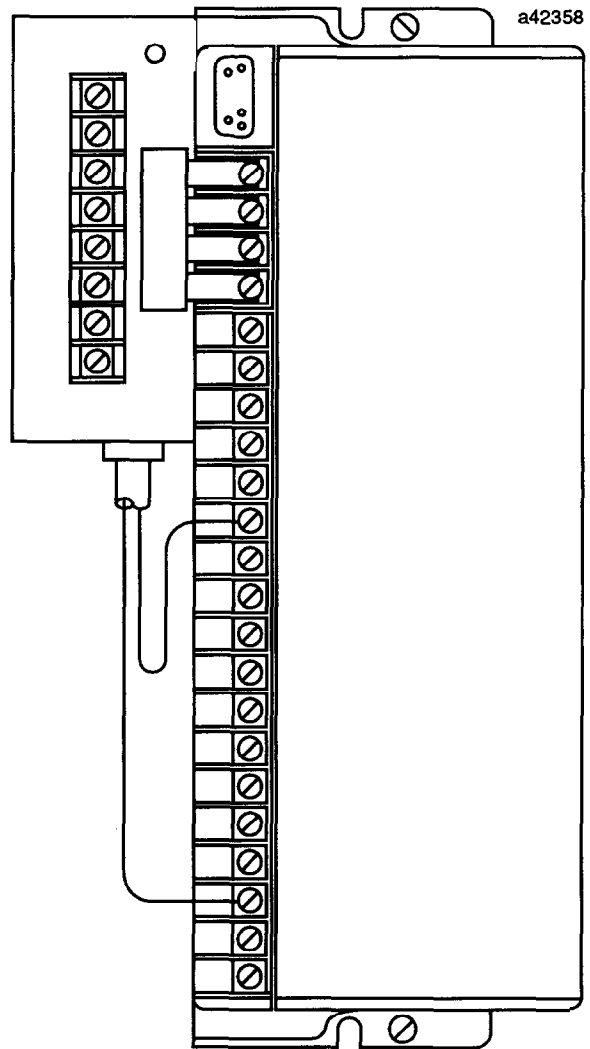

GFK-0072D

### Using a Relay Block as a BSM Controller

If a Relay Output Block (version IC660BBR100 or BBR101) is used as the BSM's controller block, selection of which BSM to use depends on the voltage that will power the block's outputs. If this voltage will be 24/48 VDC, BSM021 is needed. If the voltage will be 115 VAC or 125 VDC, BSM120 is needed. Refer to the illustrations below.

#### Relay Block and Points Powered by 115 VAC

If the block and points are powered by 115 VAC, use BSM version BSM120.

Connect one wire of the BSM to point 1 and connect the other BSM wire to N. Jumpering terminal J1 to COM as shown below allows the points to operate on the same 115 VAC source that powers the block.

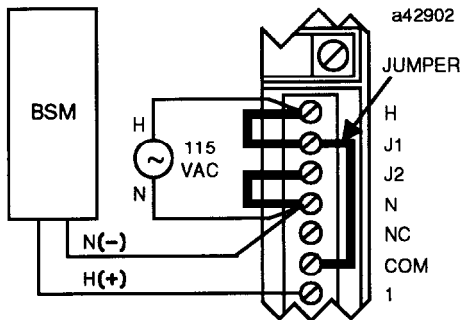

#### Relay Block Powered by 230 VAC Points Powered by 24-48 VDC

If the block is powered by 230 VAC, but the points are powered by a 24-48 VDC source, use BSM version BSM021. Connect one wire of the BSM to point 1 and the other to DC- (24-48VDC).

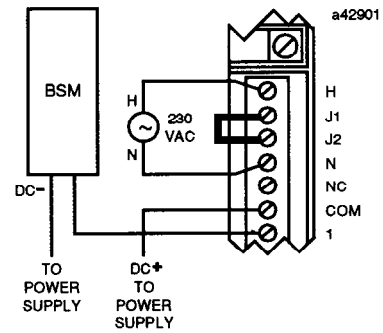

#### Relay Block Powered by 230 VAC Points Powered by 115 VAC or 125 VDC

If the block is powered by 230 VAC, but the points are powered by either a 115 VAC source or a 125 VDC source, use BSM version BSM120. Connect one wire of the BSM to point 1. For a 125 VDC source, connect the other BSM wire to DC-. For a 115 VAC source, connect the other BSM wire to the neutral side of the power supply.

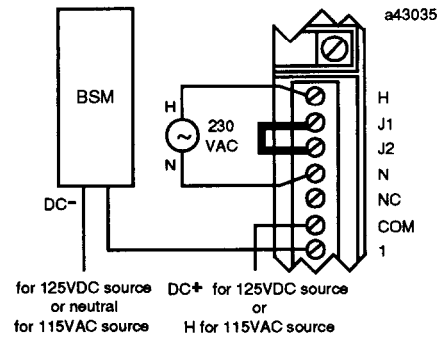



GFK-0072D

## Prefabricated Cables

Prefabricated cables are available which can be used to simplify bus stub wiring. These cables come in 15-inch and 36-inch lengths, and have built-in connectors at both ends. See the Ordering Information on the last page of this data sheet.

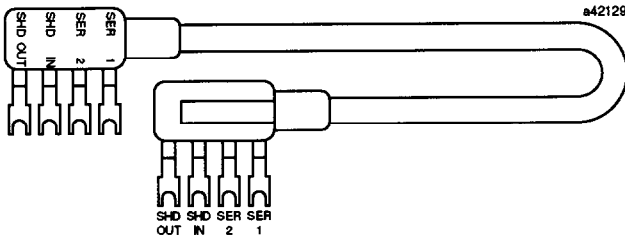

## Connecting the Blocks

Always use the prefabricated cables or Belden 9182 or equivalent for BSM stub connections, regardless of the cable type used for the cable trunk.

1. Attach one end of the bus stub cable over the BSM connectors on the controller block. Tighten the Serial 1 and 2 and Shield In and Out terminal screws.
2. Connect the other blocks on the stub, keeping cable stub length as short as possible. The prefabricated cables have connectors that are notched to fit together securely. At each block on the stub, attach the cables from the previous block and the next block to the Serial 1 and 2 and the Shield In and Out terminals. Tighten the terminals.

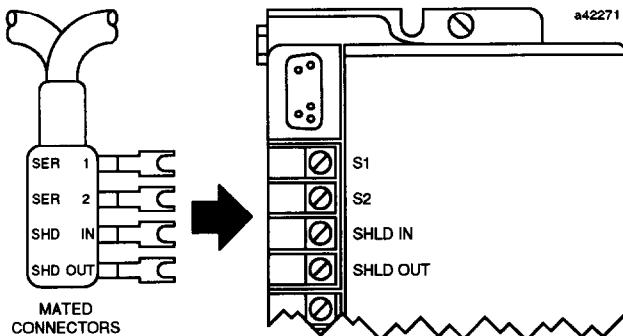

3. The bus stub that connects the blocks in the cluster does *not* require a terminating resistor.

## Removing the BSM

It is seldom necessary to remove a Bus Switching Module in an operating system. The Electronics Assembly of the block to which the BSM is attached can be removed and replaced without disturbing the block's Terminal Assembly or the Bus Switching Module. If it is necessary to remove a Bus Switching Module or the Terminal Assembly to which it is attached, the system should be powered down.

### WARNING

**A Bus Switching Module should not be removed while the system is operating. Removing a BSM disrupts communications on the bus, and can lead to unexpected and possibly hazardous control conditions.**

If it should be necessary to remove a BSM without powering down the block to which it is attached, first remove the BSM's pigtail cable from the block. Use an insulated screwdriver to carefully disconnect the pigtail wires, which carry either 115VAC/125VDC or 24/48VDC power, from the block terminals.

### WARNING

**Do not remove the BSM with the pigtail cable connected to a block that has power applied. Electric shock may result.**

## Configuration Information

The BSM controller and the other blocks on the stub must be configured using a phase B Hand-held Monitor (IC660HHM501). Configuration requirements for the BSM controller block and other blocks in the cluster are summarized below. For more information, see the *Genius I/O System User's Manual*.

### Configuring the BSM Controller Block

For the BSM controller block, select the following configuration option:

*BSM Controller: enable*

This reserves the *first circuit on the block* for use as an output controlling the BSM. If the block has selectable inputs and outputs, it is possible for the block to be used as an inputs-only block, but circuit #1 cannot be physically used as an input.

### Configuring All Blocks in the Cluster

For all blocks on the stub, including the BSM controller, select the following configuration option:

*BSM Present: enable*

Select other options for the block that are appropriate for that block type.

For blocks with outputs, if BSM present has been selected, the *Outputs Timeout Select* option sets either 2.5 or 10 seconds as the delay before the block's outputs will default. Use 2.5 seconds unless the bus scan time is over 100mS.

## Switching the BSM on Command

The CPU or a phase B Hand-held Monitor can switch the BSM to either bus.

To switch the BSM from the CPU, use the Switch BSM command in the program. This command allows the BSM to switch again subsequently.

If the BSM is forced using the Hand-held Monitor, the BSM cannot switch again until unforced. To force the BSM from the Hand-held Monitor.

1. From the Home menu, select ANALYZE (F2). From the Analyze menu, select MONITOR/CONTROL REFERENCE (F2). The HHM shows the active bus, and indicates whether it is forced. For example:

```

M N T R / C T R L      1 7
S T A T E :   B U S   B
>   b u s A   b u s B   r e l s
    
```

2. To force the BSM to select the other bus, select either busA (F2) or busB (F3). The HHM displays the forced bus.

```

M N T R / C T R L      1 7
S T A T E :   B U S   A   F R C
>   b u s A   b u s B   r e l s
    
```

3. Check the LED on the Bus Switching Module. It will be off when bus A is selected and on when bus B is selected.



GFK-0072D

## Bus Switching Module Specifications

<b>Operating temperature</b>	0°C to 60°C (32°F to 140°F)
<b>Storage temperature</b>	-40°C to +70°C (-40°F to 158°F)
<b>Humidity</b>	5% to 95% (non-condensing)
<b>Size (HxWxD)</b>	3.50" x 2.25" x 2.5" (8.9cm x 5.72cm x 6.35cm)
<b>24/48 VDC Block</b>	
<b>Input voltage</b>	
<b>Bus B selected:</b>	18 VDC to 56 VDC (not polarized)
<b>Bus A selected:</b>	Less than 4 VDC (not polarized)
<b>Current draw</b>	
<b>at 24 VDC:</b>	17mA maximum, 10mA minimum
<b>at 48 VDC:</b>	60mA maximum, 30mA minimum
<b>115 VAC/125 VDC Block</b>	
<b>Input voltage, 50/60Hz</b>	
<b>Bus B selected:</b>	90 VAC minimum to 130 VAC maximum, or 95 VDC minimum to 150 VDC maximum
<b>Bus A selected:</b>	Less than 35 volts AC or DC
<b>Current draw, 50/60Hz</b>	
<b>at 115 VAC:</b>	40mA minimum, 60mA maximum
<b>at 120 VDC:</b>	5mA minimum, 12mA maximum
<b>Reliability</b>	500,000 operations, minimum
<b>Switch activation time</b>	Less than 20mS (including switch bounce)
<b>Switch release time</b>	Less than 70mS (including switch bounce)

### NOTE

This equipment complies with the requirements in part 15 of FCC rules for a class A computing device. Operation of this equipment in a residential area may cause interference to radio and television reception, requiring the operator to take whatever steps are necessary to correct the interference.

## Ordering Information

Description	Catalog Number
Bus Switching Module, 115 VAC/125 VDC	IC660BSM120
Bus Switching Module, 24/48 VDC	IC660BSM021
Prefabricated Cable (Belden 9182 type) 15-inch, quantity 3	IC660BLC001
Prefabricated Cable (Belden 9182 type) 36-inch, quantity 1	IC660BLC003
<i>Genius I/O System User's Manual</i>	GEK-90486