



This Datasheet is for the

IC754VBI12CTD

The IC754VBI12CTD for the GE QuickPanel has 12" TFT touchscreen

<http://www.qualitrol.com/shop/p-16514-ic754vbi12ctd.aspx>

For further information, please contact Qualitrol Technical Support at

1-800-784-9385

support@qualitrol.com

Chapter 1. Introduction	4
1.1 Specifications.....	4
1.1.1 General Specifications	4
1.1.2 Physical Specifications and Mounting	6
1.1.3 Environmental Specifications.....	6
1.2 QuickPanel+ Hardware User Features.....	7
1.2.1 Overview	7
1.2.2 Status Indicators	8
Chapter 2. Getting Started	9
2.1 Unpacking and Inspection	9
2.2 Basic Setup.....	11
2.3 Startup	11
2.3.1 Connecting Input Power	12
2.3.2 Initial Configuration	13
2.4 Runtime Setup.....	13
2.5 Firmware Updates	13
2.6 Shutdown.....	13
Chapter 3. QuickPanel+ Software	15
3.1 Operating System	15
3.2 Backup Utility	15
3.3 Storage Manager	15
3.4 Copy Project to SD Card	16
3.5 Updating a Machine Edition Project	16
3.6 FTP Server	17
3.6.1 Authentication of Remote Users.....	17
3.6.2 FTP with Removable Flash Devices.....	17
3.7 HTTP Server.....	17
Chapter 4. Installation	19
4.1 Installing the Protective Sheet	19
4.2 Choosing a Mounting Location.....	19
4.3 Panel Mounting.....	19
4.4 Mounting on a VESA Arm.....	21
4.5 Installing/Replacing the Battery	23
4.6 Connectors	25
4.6.1 Power Connector Pin-out.....	25
4.6.2 Ethernet	25
4.6.3 Serial Port	26
4.6.4 Universal Serial Bus (USB) Ports	26

Contents

4.6.5	Audio (LINE OUT) Details	30
4.6.6	Audio (MIC IN) Details	30
4.6.7	SD Card Slot	31
Chapter 5.	Detailed Operation	32
5.1	Touch Screen Display	32
5.1.1	Adjusting the Display Brightness	32
5.1.2	Configuring the Backlight	32
5.1.3	Calibrating the Touch Screen	33
5.2	Keyboard	34
5.2.1	External Keyboard (optional)	34
5.2.2	Soft Input Panel	34
5.3	Mouse	34
5.4	Memory	35
5.4.1	DRAM Memory	35
5.4.2	Changing the Memory Allocation	35
Appendix A	Product Certifications & Installation Guidelines for Conformance	36
	Agency Approvals	36
	Government Regulations	36
Appendix B	Orderable Part Numbers	37

Chapter 1 Introduction

Chapter 1. Introduction

The QuickPanel+ operator interface is an all-in-one microcomputer designed for maximum flexibility. The design, based on an advanced ARM core microprocessor, brings together a high-resolution touch-screen operator interface with a variety of communications options. You can connect to most industrial equipment through the QuickPanel+ communications ports. The QuickPanel+ is equipped with several memory types to satisfy the most demanding applications. A 512MB section of DRAM is split between the operating system, an object store and application memory. Functioning as a virtual hard drive, a 256MB section of non-volatile flash memory is divided between the operating system and persistent storage for application programs. The retentive memory consists of 512KB of battery-backed SRAM for data storage, protecting your valuable data during a power failure.

1.1 Specifications

1.1.1 General Specifications

Processor		Freescale i.MX535 (1GHz ARM Cortex A8)
Memory	RAM	DDR2 SDRAM 512MB
	ROM	SLC NAND 256MB
	SRAM	512 KB (with Battery backup)
Operating system		Microsoft Windows Embedded Compact 7
Display	Type	7" Widescreen TFT LCD
	Resolution	800(W) x 480(H) pixels WVGA
	Backlight	LED
Touch screen	Touch Panel Type	Projected Capacitive
	Multi-touch	Two-point
Communications	Ethernet Port	1x 10/100BaseT (RJ-45)
	Serial Port	1x RS-232 UART Port (5-Pin Connector)
	USB, Host	Two USB2.0 (Type-A) Max. Power (5V @ 0.5A)
	USB, Device	One USB 2.0 (Mini Type-B)
Storage		One SD/SDHC Card Slot
Audio		One Mic In (mono) (3.5mm Jack) One Line Out (Stereo) (3.5mm Jack)
Noise immunity		Noise voltage: 1500V p-p Pulse Duration: 1 μ s, Rise time: 1ns
Input power	Maximum Rated Voltage	+30VDC
	Rated Voltage	+24VDC \pm 20% (3-Pin Connector)
	Power Consumption	15W (max)
	Frame Ground	Frame GND is connected to Signal GND internally

1.1.2 Physical Specifications and Mounting

Dimensions (LxWxD)		192 mm x 137 mm x 36 mm (7.56 in. x 5.39 in. x 1.42 in.)
Weight		0.800 kg (1.76 lbs)
Mounting options	Panel cutout dimensions	183.5 mm x 128.5 mm (7.22 in. x 5.06 in.)
	VESA mount	VESA Mount: 75 mm x 75 mm

1.1.3 Environmental Specifications

Note: The QuickPanel+ shall be installed in a location that is well ventilated and not exposed to dust, corrosive gases or liquids, flammable gases, rain, strong ultraviolet light or direct sunlight, and that meets the environmental specifications listed below.

Cooling	Natural convection
Ambient Operating temperature	0°C to +50°C
Ambient Storage temperature	-20°C to +60°C
Ambient Humidity (operating and storage)	85% RH (non-condensing, wet-bulb temperature:30°C or less)
Environment	Pollution Degree 2 as defined by UL60950-1.
Vibration resistance	5 to 9Hz single-amplitude 3.5mm 9Hz to 150Hz constant-accelerated velocity 9.8m/s ² X, Y, Z directions 10 time (100minutes) (Compliance 3502, IEC61131-2 JIS B)
ROHS	Compliant with EU RoHS Directive 2002/95/EC using the following exemptions identified in the Annex: 7(a), 7(c)-I, & 7(c)-III.
Enclosure rating	IP65 and JEM1030 when installed in accordance with the instructions in Chapter 4, "Installation."

Note: For additional product standards and agency approvals, refer to Appendix A.

Chapter 1 Introduction

1.2 QuickPanel+ Hardware User Features

In addition to the primary touch screen interface, the QuickPanel+ supports a variety of communication ports. The following diagrams show the physical layout of the QuickPanel+ including locations of status LEDs, communications ports, and connectors.

1.2.1 Overview



Figure 1. QuickPanel+ Hardware Features

1.2.2 Status Indicators

The QuickPanel+ operator interface has a tri-color LED that provides visual status indications and an on-board buzzer for audio indications.

1.2.2.1 QuickPanel+ Status LED Operation

LED State	QuickPanel+ State
Amber, steady	Operating system starting
Green, steady	Normal operating state
Green, blinking	Backlight off
Red, blinking	Backlight fail
Off	Power not applied to the QuickPanel+

1.2.2.2 Ethernet Port LED Operation

The Ethernet port has two LED indicators, **ACTIVITY** and **LINK**.

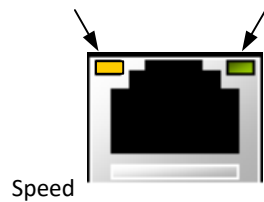

LED	LED State	Operating State
Speed	On, Yellow	10/100
Link Activity	On, Green	Link status

Link Activity

Chapter 2. Getting Started

This chapter contains information for performing a pre-installation check of your QuickPanel+ operator interface.

Before installing and using the QuickPanel+, the following steps should be completed:

- Unpacking and Inspection
- Basic Setup
- Initial Startup
- Runtime Setup
- Firmware Updates
- Shutdown

2.1 Unpacking and Inspection

Upon receiving your QuickPanel+ operator interface carefully inspect all shipping containers for damage. If any part of the system is damaged, notify the carrier immediately. The damaged shipping container should be saved as evidence for inspection by the carrier. As the consignee, it is your responsibility to register a claim with the carrier for damage incurred during shipment. However, we will fully cooperate with you should such action be necessary.

After unpacking the unit, **record all serial numbers**. Serial numbers are required if you need to contact Customer Care during the warranty period. Shipping containers and packing material should be saved in case it is necessary to transport or ship the unit.

Verify that all components of the system have been received and that they agree with your order. If the system received does not agree with your order, contact Customer Care (see “Contact Information” for phone numbers and email addresses).

Before you attempt to power up the operator interface for the first time, inspect the unit for loose or damaged components. If damage is found (for example, in the form of bent component leads or loose components), contact GE Intelligent Platforms for additional instructions.

Do not apply power to the unit if it has visible damage. Applying power to a unit with damaged components could cause additional damage.

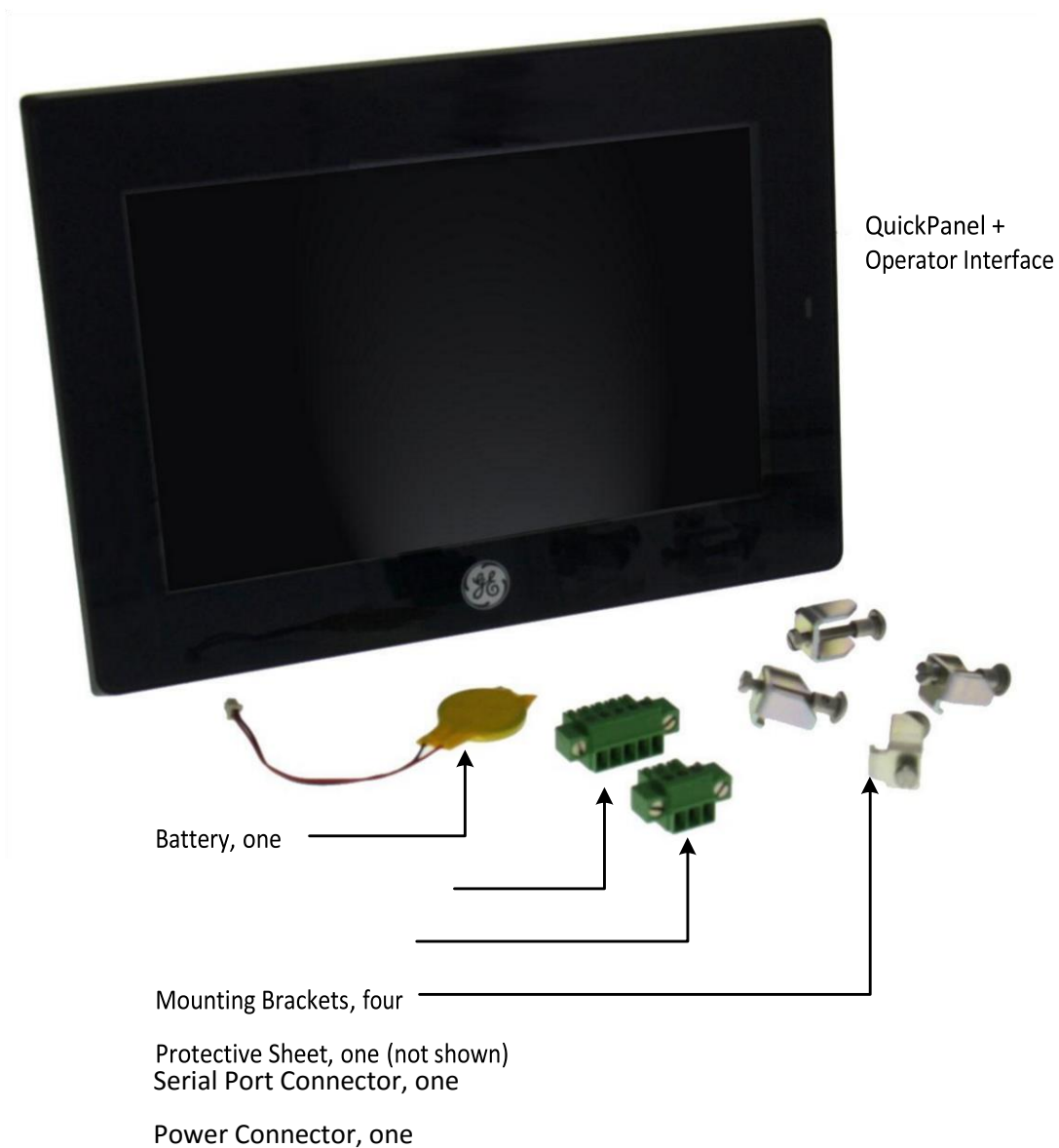

Gasket, one (not shown, pre-installed)

Figure 2. QuickPanel+ Package Contents

2.2 Basic Setup

Your QuickPanel+ is shipped ready for use after a few configuration steps. To power up, all you need to do is connect a DC power supply using the supplied quick-connect plug. Depending on your application, you may also want to connect and configure optional input devices, communications ports and expansion adapters.

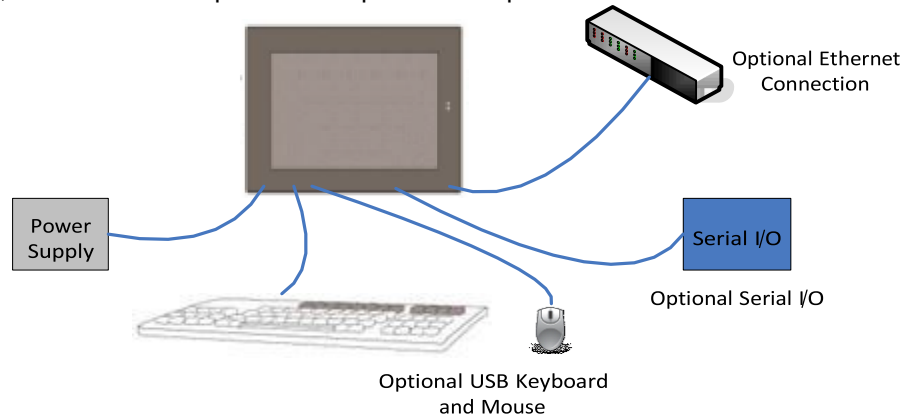

Figure 3. Basic Setup Diagram



Warning

Electrical Shock Hazard: To avoid personal injury or damage to equipment, ensure that the DC supply is disconnected from power and that the leads are not energized before attaching them to the unit's power supply plug.

2.3 Startup

You will need the following:

- A 24VDC power supply. For requirements, see the Input power specification on page 8.
A power terminal block is supplied.
- Power cord with 30 – 14 AWG (0.05 – 2.00 mm²) wires
- USB-compatible keyboard (optional)
- USB-compatible mouse (optional)

2.3.1 Connecting Input Power

1. Make sure that the power cable is not energized and that the QuickPanel+ unit is not on.
2. Loosen the screw clamps on the mating power connector
3. Strip the insulation from the power cables.
4. Secure the power cable to the mating connector while noting polarity and tighten the screw clamps. The torque for the attaching screws is 0.31 Nm.
5. Apply DC power to the unit.
During normal power up and operation, the QuickPanel Status LED display is:
 - *Solid amber* while the QuickPanel+ unit is starting up
 - *Solid green* during normal operation
6. Once power is applied, the QuickPanel+ begins initializing. The first thing to appear on the display is the splash screen.
To skip running any programs included in the StartUp folder, tap **Don't run StartUp programs**.
7. The Microsoft Windows Embedded Compact 7 operating system starts automatically. During powerup, you should see the normal operating system starting displays.
To activate the operating system online, you will need to first configure the Ethernet settings for operation on your network, as described in "Initial Configuration."
You can find the operating system product key on the Microsoft Certificate of Authenticity label, which is on the back of the QuickPanel+.

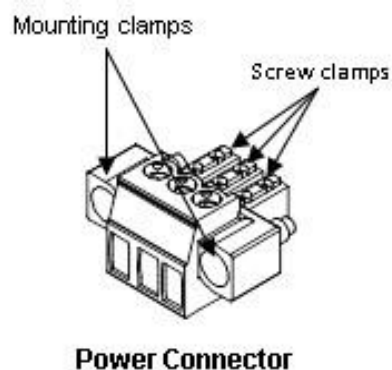

2.3.2 Initial Configuration

When you first start up the QuickPanel+, a few configuration steps are necessary.

1. Tap Start , point to Settings and then tap Control Panel.
2. In the Control Panel, double-tap Date and Time to configure the system clock.

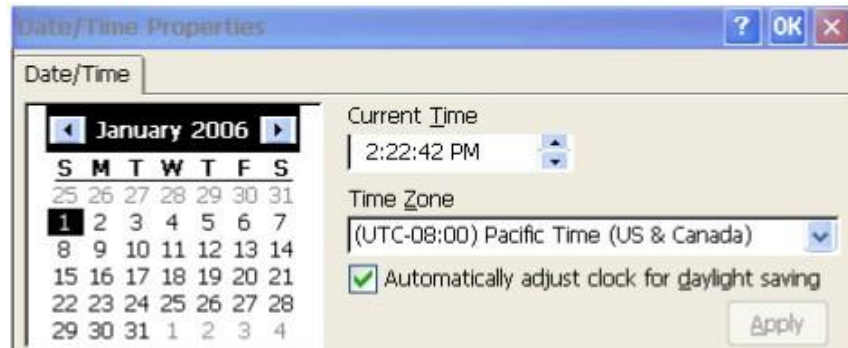

3. In the Control Panel, double-tap System to configure a network Device Name. Many applications, including Proficy Historian require a unique Device Name. It is recommended procedure to set a unique Device Name for the QuickPanel+ to avoid future conflicts.
4. In the Control Panel, double-tap Network and Dial-up Connections to configure network settings.
5. To save the settings, run Backup.

2.4 Runtime Setup

To download an application to a QuickPanel+ unit, you must set up a data link between it and your development workstation. For more information, see 4.6.2, “Ethernet.”

“Downloading a Machine Edition Project” in the Machine Edition online help.

2.5 Firmware Updates

Updates to the QuickPanel firmware are available on the Support web site. This allows you to update the unit to the most recent released version of the firmware with the latest feature updates and issues addressed.

2.6 Shutdown

There are no specific dangers associated with a power failure or other unplanned shutdown of the QuickPanel+. In general, programs are retained in flash memory and user data can be

retained in battery-backed SRAM. Some operating system settings are retained only with user intervention. We recommend the following procedure to shut down the QuickPanel+. **To shut down the QuickPanel+**

1. Quit any programs that are running and wait for all file operations to complete.
2. If you have not changed operating system settings (for example, brightness or touch screen sensitivity) or do not want to save the changes, remove AC power from the DC supply.
3. To save changes to operating system settings run Backup. When the Backup dialog box displays *Completed Successfully*, remove power from the DC power supply connected to the QuickPanel.

Chapter 3. QuickPanel+ Software

This chapter provides introductory information on the QuickPanel+ software with procedures for completing some of the most common tasks you will encounter.

3.1 Operating System

Microsoft Windows Embedded Compact 7 is the operating system for the QuickPanel+. It is a full 32-bit O/S with a graphical user interface.

The QuickPanel+ operating system is stored in flash memory and copied to a block of DRAM for execution. The operating system starts automatically following a power-up or reset of the QuickPanel+.

For detailed information about using the operating system, refer to <http://windows.microsoft.com>.

3.2 Backup Utility

Backup saves changes that you make to the Windows Registry or Desktop to Flash memory. This utility is required because the QuickPanel+ is not battery powered. Specifically, Backup does the following:

- Stores the Windows Embedded Compact 7 registry (including any control panel settings) in Flash memory.
- Stores any changes (or additions) made to the 'Windows' subtree of the file system in the user block of flash memory.

Run Backup whenever you make configuration changes to the operating system or installed applications, and before shutting down the QuickPanel+.

3.3 Storage Manager

Use Storage Manager to repair or format lost or corrupted data volumes. Storage Manager can repair data volumes existing either in SD Card, battery-backed SRAM (BBSRAM), or USB Flash Keys (thumb drives). Data volumes existing in the main flash file system of the QuickPanel+ may not be repaired by Storage Manager.

Storage Manager, accessed from the Control Panel folder, is a Microsoft product for which on-line help is available.

3.4 Copy Project to SD Card

This is a custom utility for transferring Proficy Machine Edition View and Control projects between compatible QuickPanel+ units via SD cards.



Caution

Ensure that the copy or update operation is complete (i.e., no busy or wait cursor displays) before disconnecting power.

To copy a Machine Edition project to SD card

1. Ensure there is a blank SD card in the SD card port.
 2. Double tap the **Copy Project to SD Card** icon on the desktop.
 3. Tap **Yes** when the **Copy Project Query** confirmation dialog box appears.
-



Caution

Copying a project while the Proficy Machine Edition runtimes are active may cause an incomplete copy to be created if the runtimes are also writing to files in the project folders. The utility can detect this situation and will notify you to stop the runtimes before making the backup. You will not be able to create a backup while the runtimes are writing files.

3.5 Updating a Machine Edition Project

You can update a Machine Edition application currently stored on the QuickPanel+ with a revision stored on a flash device, such as a SD card.

1. Insert the flash device containing an upgraded version of the Machine Edition project into the appropriate port.
2. Reboot the machine
See the settings section below, as depending on options set, the update may or may not be enabled, or may automatically update. If there is more than one flash device with a valid project copy present, a Select Media confirmation dialog will appear allowing you to choose which flash device to update with. Select the device from the list and select OK to continue. When a valid project is found on the flash device, you will be prompted to install the project or skip it. Tap OK to install or Cancel to skip the install and continue to boot. If an invalid project is found, an error message appears in a dialog box. This dialog box must be closed before boot will continue.
3. Remove the flash device from the port.

Chapter 3 QuickPanel+ Software

3.6 FTP Server

The FTP Server included with the QuickPanel+ supports standard (RFC 959). It does not support SFTP or implicit FTPS, which uses different ports and is based on SSH rather than SSL.

The configuration of the FTP server is accomplished with the Quick Panel+ Setup Tool. By default, the server is not enabled. Once enabled, a background program will run, waiting for clients to connect. Up to ten connections are supported. Sessions that are idle for five minutes are terminated by the server.

The Server supports:

- Non-secure operation. All information including username, password, and data is transmitted with no encryption and susceptible to packet sniffing and various FTP attacks.

Note: If the server status is changed, the QuickPanel+ must be re-booted before changes take effect.

3.6.1 Authentication of Remote Users

The server only supports anonymous login.

- Anonymous with password requested (but not validated). This can prevent some types of attacks and is required by some clients.

Once connected, a remote user is logged into the FTP root directory. This is available from the QuickPanel+ as \ and is the root of the flash device.

3.6.2 FTP with Removable Flash Devices

All removable flash devices appear to remote FTP users as directories off the FTP root directory. PC Flash card partitions appear as directories such as \SDMemory and USB Flash Keys as directories such as \Hard Disk. Full access privileges are granted for the client in these folders/devices.

Removable flash device directories are captured when a session is opened and are not changed while the session exists. If you start without an SD Card installed, you will have to close your session and login again to see the SD Card directory. If the SD Card existed when you logged in and is removed and inserted, it will still work, provided the SD Card's device name did not change during reinsertion.

3.7 HTTP Server

The HTTP Server included with the QuickPanel+ supports standard (RFC 2616).

The configuration of the HTTP server is accomplished with the Quick Panel+ Setup Tool. By default, the server is not enabled. Once enabled, a background program will run, waiting for clients to connect. The default web page is located in \Windows\www\wwwpub on the QuickPanel+.

The Server supports:

- Non-secure port 80 operation.

Note: If the server status is changed, the QuickPanel+ must be re-booted before changes take effect.

Chapter 4. Installation

This chapter provides the following procedures for installing the QuickPanel+ unit:

- Installing the Protective Sheet
- Choosing a Mounting Location
- Panel Mounting
- Mounting on a VESA Arm
- Installing/Replacing the Battery
- Connectors

4.1 Installing the Protective Sheet

1. Wipe the display of any dust or fingerprints.
2. Peel a corner of the clear side of the protective sheet.
3. Begin applying the corner to the display.
4. Slowly apply the rest of the protective sheet, smoothing out as you go.
5. Peel the green curing film off the protective sheet.

4.2 Choosing a Mounting Location

When mounting the QuickPanel+ make sure that the mounting area allows room to insert and remove the SD card, cables, and mounting brackets. The QuickPanel+ should not be mounted at an angle more than 30° from the vertical as illustrated below.

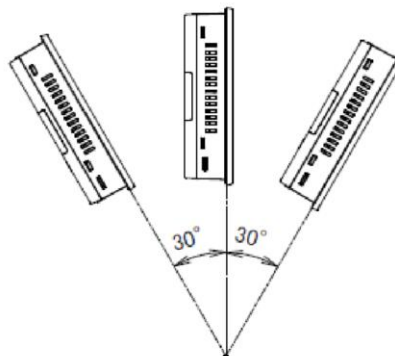

Figure 4. Mounting Angle

Choose a location that will allow natural convection air flow from bottom to top of the QuickPanel+ unit.

For environmental requirements, see 1.1.3, “Environmental Specifications.”

4.3 Panel Mounting

To mount the QuickPanel+ in an enclosure, you will need:

- a Phillips head screwdriver
- four mounting brackets (supplied)

The QuickPanel+ has four mounting holes located on the top and bottom of the unit. The mounting holes are indicated in the drawing below.

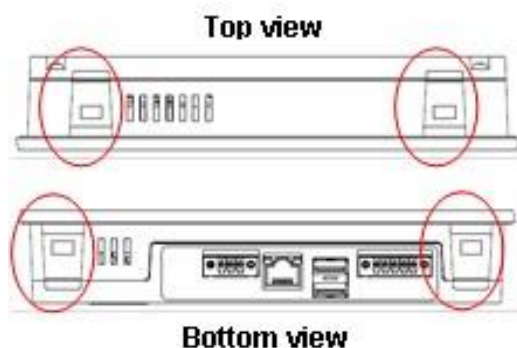

Figure 5. Mounting Holes

Installation Notes:

- To avoid gasket degradation, limit repeated insertions or removals of the unit and retightening of the mounting clips. For full protection, always use a fresh gasket. Replacement gaskets can be ordered using the part number listed in Appendix B.
- The unit will not fit through the cutout with any cables connected, or with the power supply plug inserted in the socket.

1. Cut an opening in the panel according to the specifications in the diagram below. Panel thickness supported: 1.0mm to 5.0mm.

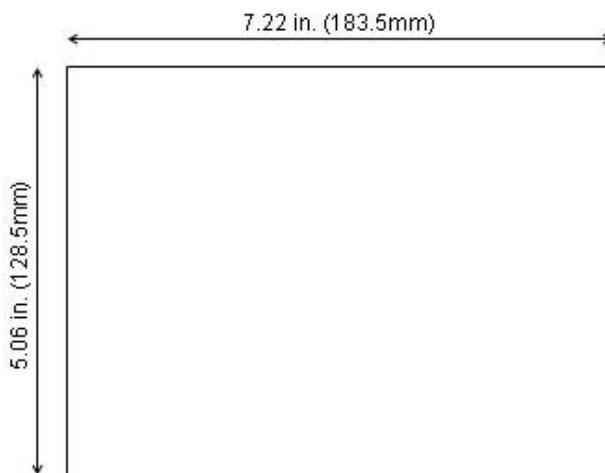
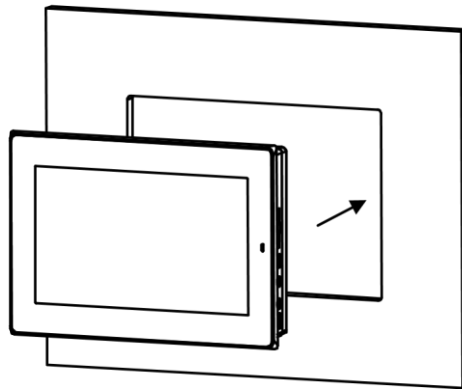
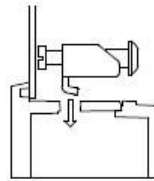

Figure 6. Panel Cutout Dimensions for 7" QuickPanel+

2. Slide the QuickPanel+ into the mounting panel cut-out.



3. Verify that the gasket is in the bezel channel located on the sides of the QuickPanel+.
4. Insert the hook of the mounting bracket into the mounting hole as shown below.



5. Tighten the screws on the mounting bracket in the clock-wise direction.

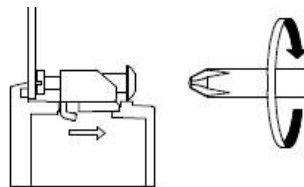

Note: The torque range for the mounting clamp screws is (0.3 Nm).

4.4 Mounting on a VESA Arm

The QuickPanel+ can be installed on a commercially available Video Electronics Standards Association (VESA) MIS-D 75mm arm. To mount the QuickPanel+, use the mounting holes located on the back of the unit. The mounting holes are 75mm (2.95 inches) apart and attach with M4 screws that are 6mm (0.24 inches) or less in diameter.

Note: The torque range for the mounting M4 screws is (0.7 – 0.8 Nm). Refer to the mounting arm manual for instructions.

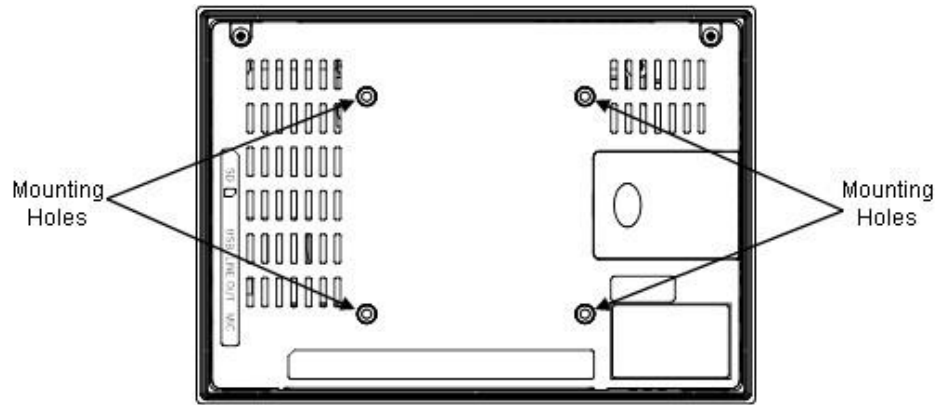

4.5 Installing/Replacing the Battery

1. Remove the battery cover by pressing down while sliding outward.

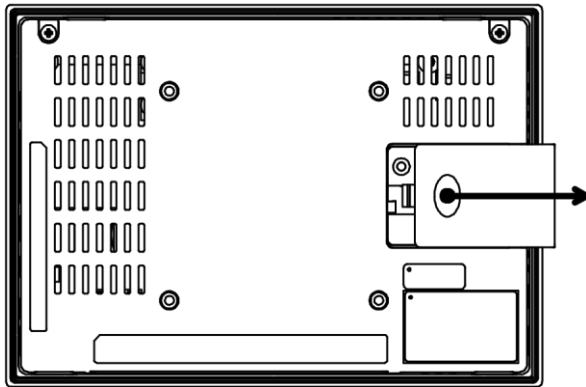

2. Connect the harness connector of the battery to the header, noting keyed orientation.

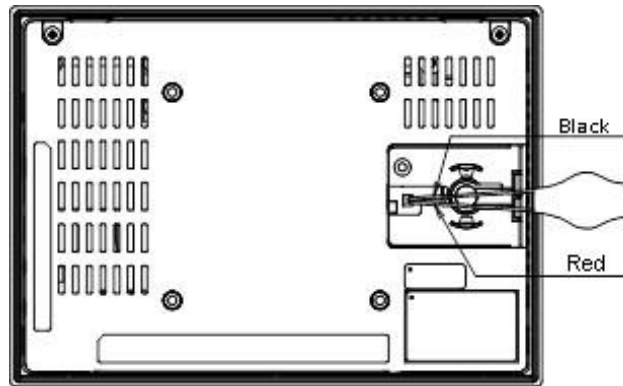

3. Pull Make sure that positive (red) is down and negative (black) is up
4. Wrap harness connector around to match the picture below.
5. Do not let the harness connector go above the tab.

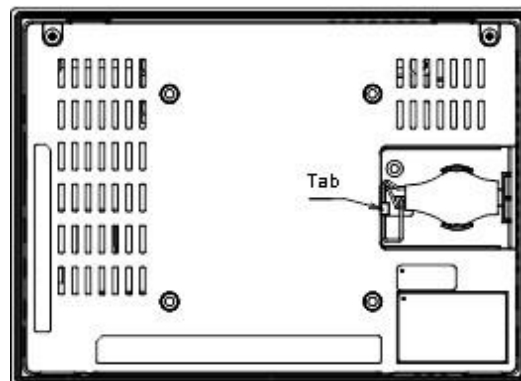

6. Slide the battery cover into place, taking care not to pinch the harness connector.

Warning



Batteries may present a risk of fire, explosion, or chemical burn if mistreated. Do not crush, disassemble, short-circuit, or dispose of in fire.

Use of batteries not specified for use with the QuickPanel+ product may present a risk of fire or explosion.



Lithium Battery Warning

Do not recharge, disassemble, heat or incinerate lithium batteries.

Dispose of lithium batteries in accordance with federal, state, and local regulations. Be sure to consult with the appropriate regulatory agencies before disposing of batteries.

4.6 Connectors

4.6.1 Power Connector Pin-out

Interface: 24VDC IN

Connector: Terminal Euro (Tyco Electronics 284539-3 or equivalent)

Pin number	Signal name	Pin-out
1	+24 VDC	
2	GND	
3	FG	

Mating Connector: (Tyco Electronics 284510-3 or equivalent)

To connect the power supply, refer to 2.3.1 “Connecting Input Power.”

4.6.2 Ethernet

The QuickPanel+ is equipped with one 10BaseT/100-BaseTX Ethernet port. You can connect an Ethernet network cable (unshielded, twisted pair, UTP CAT 5) to the unit via the RJ-45 connector on the bottom of the enclosure. LED indicators on the port indicate channel status (see “Ethernet Port LED Operation” on page 11). The port can be accessed by Windows Embedded Compact 7 network communications or by your application.

Ethernet Port Details

Interface: Ethernet 10BASE-T/100BASE-TX

Connector: RJ-45

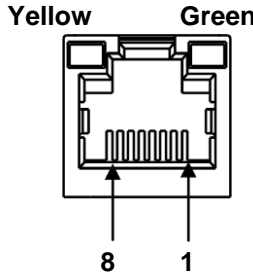
Pin Number	Signal Name	Pin-out
1	TX +	
2	TX-	
3	RX +	
4	NC	
5	NC	
6	RX-	
7	NC	
8	NC	

4.6.2.1 Setting an IP Address

The QuickPanel+ provides two methods for setting an IP address:

- **DHCP (Dynamic Host Configuration Protocol).** The network server assigns an IP address while the QuickPanel+ is initializing. (You must be connected to the network). There must be a DHCP server on the connected network for a valid IP address to be assigned. Contact your network administrator to ensure correct DHCP server configuration.
- **Manual method.** You specify the numeric addresses obtained from your network administrator for the QuickPanel+ IP Address, Subnet Mask and Default Gateway (if applicable).

Note: To save the settings, run the **Backup** utility.

4.6.3 Serial Port

4.6.3.1 Serial Port Details

Interface: RS-232

Connectors: Euro Terminal (Tyco Electronics 284539-5 or Equivalent)

Pin Number	Signal Name	Pin-out
1	TXD	
2	RXD	
3	RTS	
4	CTS	
5	SGND	

Mating Connector: (Tyco Electronics 284 510 or Equivalent)

4.6.4 Universal Serial Bus (USB) Ports

4.6.4.1 USB Host Port Details

The QuickPanel+ has two full-speed USB 2.0 host ports. A variety of third-party USB peripheral devices are available.

Each connected USB device requires a specific driver. The driver supplied with the QuickPanel+ is for optional keyboard or mouse support; other devices require the installation of custom driver software.

Interface: USB2.0

Number of Ports: Two

Connector: Type-A connector

Maximum Supply Current: 0.5A (per port)

Pin Number	Signal Name	Pin-out
1	USB_VCC	
2	USB_D-	
3	USB_D +	
4	USB_GND	
/		

4.6.4.2 USB Device Port Details

The USB device port allows the QuickPanel+ operator interface to be used as slave device.

Interface: USB2.0

Number of Ports: One

Connector: Type-B Mini connector

Pin Number	Signal Name	Pin-out
1	VCC	
2	D-	
3	D+	
4	NC	
5	GND	

4.6.5 Audio (LINE OUT) Details

Interface: LINE OUT (stereo)

Connector: ϕ 3.5 mm Jack

Pin Number	Signal Name	Pin-out
1	GND	
2	Lineout R	
3	Lineout L	

Maximum output level: 1Vrms

4.6.6 Audio (MIC IN) Details

Interface: MIC IN (monaural)

Connector: ϕ 3.5 mm Jack

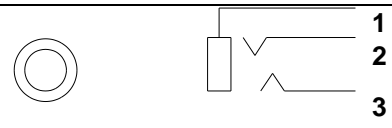
Pin Number	Signal Name	Pin-out
1	GND	
2	NC	
3	MIC	

Maximum input level: 250mVrms

4.6.7 SD Card Slot

The QuickPanel+ is equipped with one standard SD Card port. SD/SDHC memory cards are supported. The SD card slot is spring loaded for easy insertion and removal.

4.6.7.1 Storage Details

Connectors: SD card slot (push in - push out method)

Card support: SD / SDHC memory card

Maximum capacity: 32GB

Note the orientation of the SD card in the diagram below when inserting.

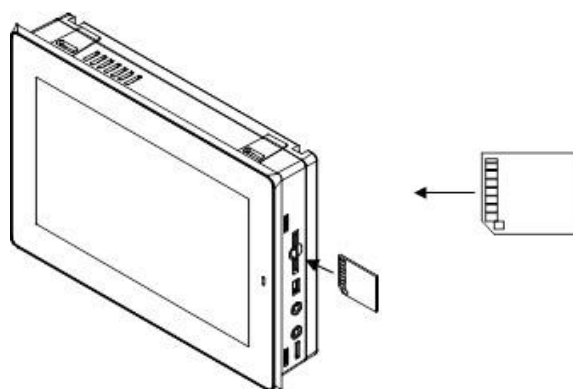

Chapter 5. Detailed Operation

5.1 Touch Screen Display

The QuickPanel+ features a 7" LED Backlit LCD touchscreen display with two-point touch. The touch technology is based on projected capacitance. This allows tracking of the finger without pressured contact conducive to smooth scrolling and multi-touch gesturing capability. Display brightness and backlight operation can be set using the operating system Control Panel.

5.1.1 Adjusting the Display Brightness

1. In the Control Panel, double tap Display and choose the Brightness tab. The Brightness dialog box appears.
2. Drag the Brightness slider between Lowest and Highest.
3. Tap OK to exit the control panel.
4. To save the settings, run the Backup utility.

5.1.2 Configuring the Backlight

1. In the Control Panel, double-tap Display and choose the Backlight tab. The Backlight dialog box appears.

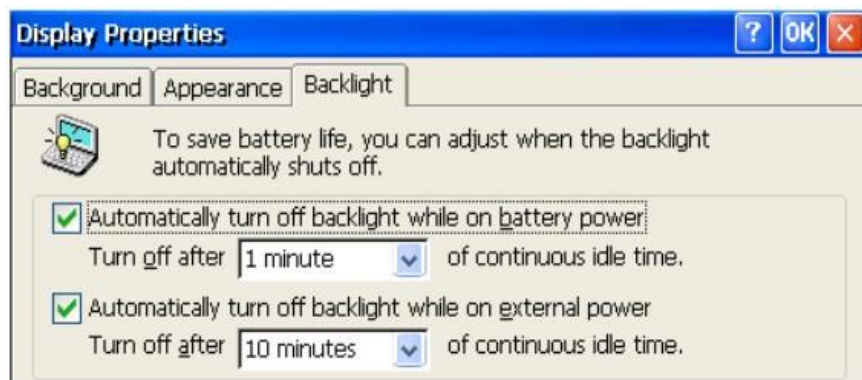

2. Select Auto turn off backlight while on external power.
3. Tap OK to exit the control panel.
4. To save the settings, run the Backup utility.

Chapter 5. Detailed Operation

5.1.3 Calibrating the Touch Screen

The touchscreen on the QuickPanel+ comes out of the box pre-calibrated but may need to be recalibrated if there are any issues with touch screen responsiveness.

1. Go to the QuickPanel+ Setup tool.
2. Click on the TouchPanel tab.
3. Select Recalibrate Touch Screen.
4. After this is complete, select Recalibrate Touch Sensor.
5. During the calibration of the touch screen sensor a prompt to activate a switch located in the battery compartment will appear.
6. Remove the battery cover and press the switch.

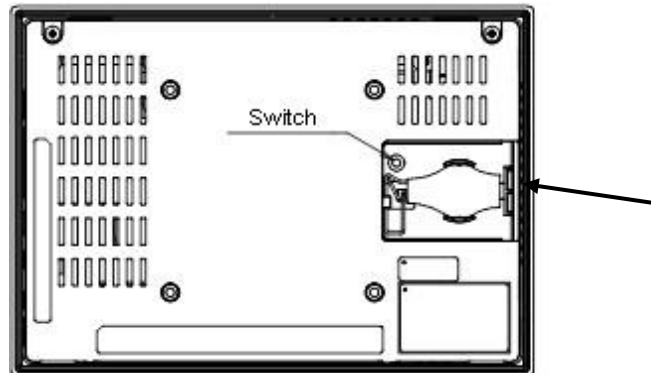

7. Replace the battery cover.

Chapter 5 Detailed Operation

5.2 Keyboard

The QuickPanel+ can be configured to use either or both a hardware keyboard and a software emulation keyboard as operator data input devices. Typically, an external hardware keyboard is used when in a development mode, while the included Soft Input Panel is more applicable in an operational environment.

5.2.1 External Keyboard (optional)

Any USB-compatible keyboard can be used as an input device for the unit. The USB driver for the keyboard is included with the operating system and no setup is required. To use an external keyboard, simply plug and play.

5.2.2 Soft Input Panel

The Soft Input Panel (SIP) is a touch screen version of a standard keyboard, which can be used in place of a standard hardware keyboard. An icon in the system tray lets you view or hide the SIP.

To show/hide the Soft Input Panel

On the system tray of the task bar, tap on the icon. The Soft Input Panel can be hidden by selecting 'Hide Input Panel'.

Note: When the SIP is visible, it can be dragged around the screen by its title bar to reveal different parts of the screen that would be obstructed from view by the SIP.

5.3 Mouse

Any USB-compatible mouse can be used as an input device for the unit. The USB driver for the mouse is included with the operating system and no setup is required. To use an external mouse, simply plug it into the appropriate port.

Chapter 5. Detailed Operation

5.4 Memory

5.4.1 DRAM Memory

The QuickPanel+ is equipped with 512 MB of dynamic RAM. Part of the DRAM is reserved for the Windows operating system and is not accessible by user applications. The remaining memory is split between two functions: an object store for temporary file storage and the main memory for running programs.

Typically, compressed programs stored in flash memory are expanded and moved to DRAM for execution. Temporary storage of program variables or data files is also provided by DRAM. Any data stored in DRAM is not retained through a power cycle or reboot. The split between program memory and storage memory can be adjusted as necessary to make more room for one or the other, depending on your specific application needs. For example, if you find that an application is short of memory, use the System Properties dialog box to alter DRAM memory allocation.



Caution

Setting Program Memory too low may prevent additional applications from starting, or may cause currently running applications to fail due to lack of memory. Setting Storage Memory too low may prevent the saving of files into the object store portion of the file system, which may also cause application failures.

5.4.2 Changing the Memory Allocation

1. In the Control Panel, double-tap System. The System Properties dialog appears.



2. On the Memory tab, drag the slider to divide into Storage and Program memory. The amount of memory allocated to and used by each area is shown in the dialog box. The blue bar indicates the current amount of unallocated SDRAM and determines the boundaries within which the slider can move.
3. Tap OK to apply the new setting.
4. To save the settings, run the Backup utility

Appendix A Product Certifications & Installation Guidelines for Conformance

The QuickPanel+ operator interface is intended for use in industrial environments and when properly installed shall comply with the following agency approvals.

Agency Approvals

<i>Description</i>	<i>Agency Standard or Marking</i>	<i>Comments</i>
N.A. Safety for Information Technology Equipment		Certification by Underwriter's Laboratories to UL 60950-1 and CSA 60950-1
Low Voltage Directive		Self-Declaration in accordance with
European Safety for Industrial Control Equipment		European Directives; Refer to Declaration of Conformity found at http://www.ge-ip.com/ for a complete list of approved products
Electromagnetic Compatibility Directive European EMC for Industrial Control Equipment		Self-Declaration in accordance with European Directives; Refer to Declaration of Conformity found at http://www.ge-ip.com/ for a complete list of approved products

Note: The agency approvals listed above and on the Declaration of Conformities are believed to be accurate; however, a product's agency approvals should be verified by the marking on the unit itself.

Government Regulations

The FCC requires the following note to be published according to FCC guidelines:

Note: This equipment has been tested and found to comply with the limits for a Class A digital device, pursuant to Part 15 of the FCC Rules. These limits are designed to provide reasonable protection against harmful interference when the equipment is operated in a commercial environment. This equipment generates, uses, and can radiate radio frequency energy and, if not installed and used in accordance with the instruction manual, may cause harmful interference to radio communications. Operation of this equipment in a residential area is likely to cause harmful interference in which case the user will be required to correct the interference at his own expense.

Changes or modifications to this unit that are not expressly approved by GE Intelligent Platforms could void the user's authority to operate the equipment.

Industry Canada requires the following note to be published:

Note: This Class A digital apparatus complies with Canadian CAN ICES-3 (A)/NMB-3(A).

Appendix B. Orderable Part Numbers

Appendix B Orderable Part Numbers

IC755CSW07CDA	QuickPanel+, 7" Color TFT Widescreen with Multi-touch Projected Capacitive Screen, 24 VDC Powered
IC755ACC07GAS	QuickPanel+ 7" Replacement Gasket
IC755ACC07MNT	QuickPanel+ 7" Accessory Kit - Replacement Mounting Clips, Power & Serial Port Connectors
IC755ACC07PRO	QuickPanel+ 7" Replacement Screen Protectors, Package of 3
IC755ACCBATT	QuickPanel+ Replacement Battery Pack
IC755ACC07ADP	QuickPanel+ Panel Adapter Kit - 8" QuickPanel View/Control to 7" QuickPanel+

- Accessories
 - part numbers, 37
- Agency approvals, 36
- Audio
 - LIN
 - E
 - OU
 - T, 30
 - MIC IN, 30
- Backlight
 - adjusting, 32
- Backup, 18
- Battery installing, 25
 - replacement, part number, 37
- Brightness
 - adjusting, 32
- Calibration
 - touch screen, 33
- Configuration
 - initial, 16
- Connectors, 27
- Declaration of Conformities, 36
- Device name, 16
- Dimensions, 9
- Display
 - setting, 32
 - s, 32
- Environmental specifications, 9
- Ethernet, 27
- External keyboard, 34
- FCC notice, 36
- FTP server, 20
- Government regulations, 36
- HTTP server, 20
- Industry Canada, 36
- Installation, 9, 21
 - battery, 25 guidelines for conformance, 36
 - mounting location, 21
 - panel mounting, 22
 - protective sheet, 21
 - VESA arm, 24
- Keyboard
 - Soft Input Panel, 34
- Machine Edition updating a project, 19
- Memory, 35
 - changing allocation, 35
 - DRAM, 35
- Mouse, 34
- Network device name, 16
- Operating system, 18
- Part numbers, 37
- Power connector, 27
- Product certifications, 36
- Proficy Machine Edition updating a project, 19
- Protective sheet installation, 21
- RFI standards, 36
- SD card copying a project to, 19
- SD card slot, 31
- Serial port, 28
- Server FTP, 20
 - HTTP, 20
- Setup basic, 14
- Soft Input Panel (SIP), 34
- Specifications
 - environmental, 9
 - general, 8
 - physical, 9
- Startup, 15
- Storage manager, 18
- Support website, 3
- Technical Support, 3
- Touch screen calibrating, 33
- Touch screen display settings, 32
- Universal serial bus (USB) ports, 29
- Unpacking and inspection, 12

**GE Intelligent Platforms
Information Centers**

Platforms web site:

1-800-433-2682 or 1-434-978-5100

Global regional phone numbers
are available on our web site www.ge-ip.com

Additional Resources

For more information, please visit the GE Headquarters:

Intelligent

www.ge-ip.com



©2013 GE Intelligent Platforms, Inc. All Rights Reserved *Trademark of GE Intelligent Platforms, Inc.

All other brands or names are property of their respective holders.

GFK-2847